

INSTRUCTION MANUAL



AUTOMATIC SPIRAL MIXERS 80-200 MODELS CPM, CPMel

Index

<i>General Information</i>		<i>Pag.4</i>
Documentation supplied		4
This manual		4
Information property rights		4
Conventions		5
Manufacturers identification details		6
Machine identification details		6
EC declaration of conformity CE		7
Guarantee		7
Use of the manual		8
Description of the machine		9
Main parts of the machine		10
<i>Security information</i>		<i>11</i>
Safety criteria		11
Qualification of personnel		12
Safeguards		13
Hazardous areas and residual risks		16
<i>Machine specification</i>		<i>17</i>
Technical specifications		17
<i>Installation</i>		<i>18</i>
Hazardous areas and residual risks during installation		18
Qualifications of the operator		18
Transport		19
Preliminary operations		21
Installation		21
Preparation for start-up		22
Testing		22
<i>Operator interface</i>		<i>24</i>
Controls		
<i>Machine operation</i>		<i>26</i>
Qualification of the operator		26
Spiral mixer model CPM		26
Spiral mixer model CPMel		28
<i>Maintenance</i>		<i>33</i>
Routine maintenance		33
Scheduled servicing		33
Head belts tightening procedure		34
Bowl belts tightening procedure		35

<i>Trouble-shooting</i>	<i>36</i>
Qualification of the operator	36
<i>Machine scrapping</i>	<i>38</i>
Qualification of the operator	38
Disconnecting the machine	38
Disconnecting procedure	38
Residual risks after machine disconnection	39
<i>List of attached documentation</i>	<i>39</i>

Cap. 1

General information

1.1 Documentation supplied

- Instruction manual (this booklet)
- Spare parts catalogue

Other documentation

- Wiring diagrams
-

1.2 This manual

ADRESSEES

- Carrier
 - Installer
 - End user
 - Maintenance engineer
-

1.3 Information property rights

This manual contains copyright information. All rights are reserved. No part of this manual can be reproduced or photocopied without prior written permission of the manufacturer. Permission to use this documentation has only been given to the customer to whom this manual has been supplied as part of the machine's equipment and only for the purpose of installation, operation and maintenance of the machine to which the manual refers.

The manufacturer declares that all the information contained herein is in accordance with the technical and safety specifications of the machine to which the manual refers. The manufacturer will not be held responsible for direct or indirect damage or injury to people, objects or animals resulting from the use of this documentation or the machine in non-standard conditions.

The manufacturer reserves the right to introduce technical modifications or improvements both to the documentation and to the machines without prior notice. Modifications and improvements may also concern machines of the same model described in this manual, but which have a different serial number. The information contained herein refers in particular to the machine specified in 1.6 " Machine identification details " .

1.4 Conventions

LINGUISTIC CONVENTIONS

- **On the left, on the right** : When speaking of such, we refer to the operator's position when facing the control panel.
- **Qualified workers** : all those people who thanks to their training, experience, education as well as their knowledge of standards, regulations, safety precautions and operation conditions, have been authorised by the people in charge of the plant safety to carry out any necessary action and are capable of identifying and avoiding possible danger.

PRINTING CONVENTIONS

PSE: Personal Safety Equipment

(N) : Where N represents a generic number (e.g. **(3)**); symbolic representation of a control or warning device (e.g. buttons, selectors and indicator lights).

(L) : Where L represents a generic letter (e.g. **(A)**); symbolic representation of the machine.

NOTE: Notes contain important information and are highlighted separately from the text to which they refer.

BEWARE : Beware indications describe the procedures, the partial or total non-observance of which can cause damage to the machine or to the devices connected to it.

DANGER: Ranger indications describe the procedures, the partial or total non-observance of which can injure or harm the operator.

1.5 *Manufacturer identification details*



Via Perotti, 5
25125 Brescia -ITALY-
Tel: +39.030.3581864
Fax: +39.030.3581859
Mail: cpspa@cpspa.it

1.6 *Machine identification details*

Type: AUTOMATIC SPIRAL MIXER MOD. CPM 80-200

Fig. 1.1 Position of the name plate 

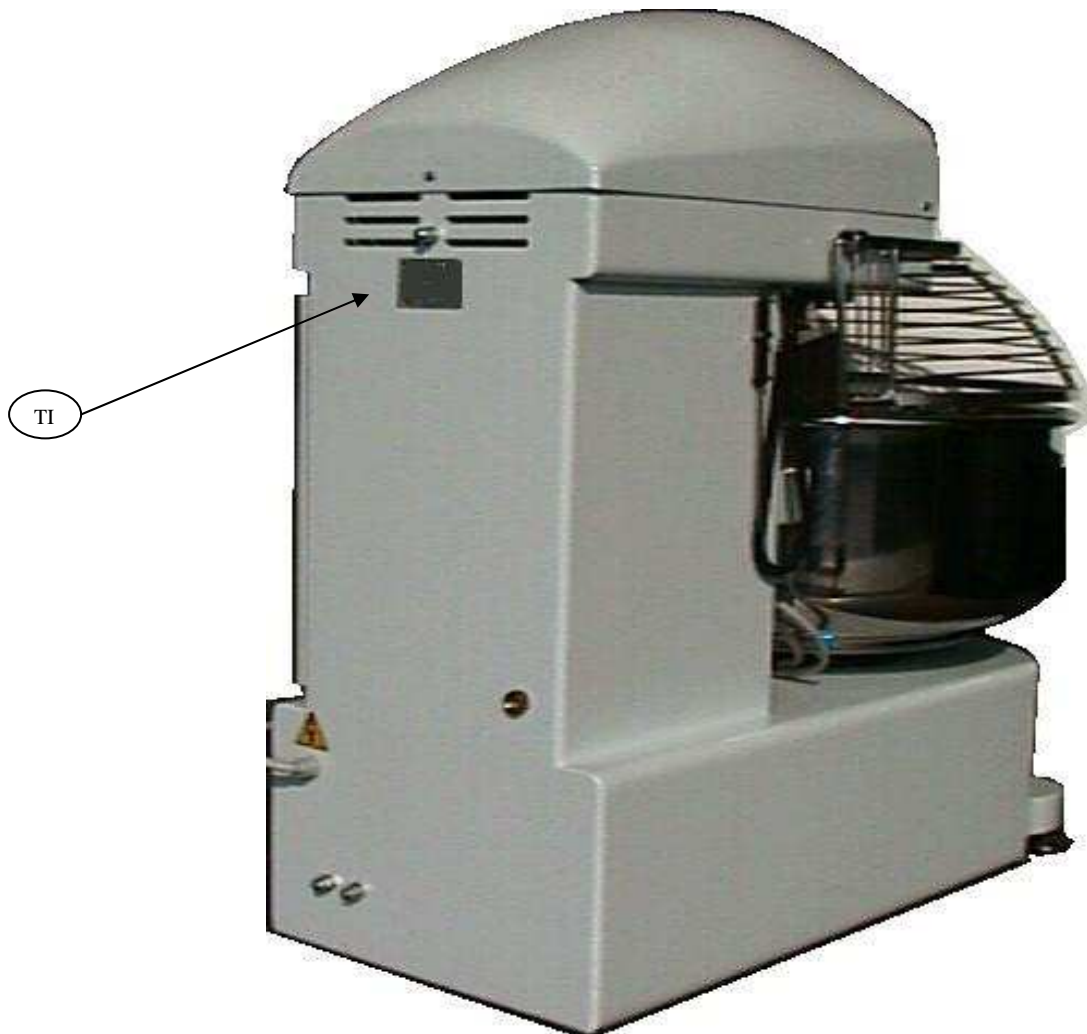

1.7 *EC declaration of conformity “CE”*

See Enclosure 1 EC declaration of conformity “CE”

1.8 *Warranty*

GENERAL CONDITIONS

- This machine (indicate the appropriate serial number) is guaranteed for 12 months. This guarantee is, however, subject to the claim being made by means of a registered letter, within 8 days after the discovery of the faults or defects providing that confirmation and acknowledgement is obtained prior from the manufacturer.
- The warranty covers the replacement or repair of the faulty part (component, machine or part of the machine) but does not cover the cost of dismantlement, re-assembly or shipping.
- The replacement of any part does not bring about the renewal of the guarantee period for the entire machine, unless the entire machine was replaced. Therefore, under no circumstance shall the manufacturer be liable for compensation of whatever type and the purchaser shall relinquish any claim for damage, loss or expense, even to third parties arising from the machine stoppage.
- The guarantee does not cover the electrical parts and the parts subject to normal wear or deterioration due to external atmospheric or environmental agents nor does it cover any defects arising from poor or insufficient maintenance, nor does it cover the misuse of unqualified personnel, unauthorised alterations or tampering of any kind.
- The validity of the warranty is subject to the performance of correct maintenance as described in Chapter 7 “Maintenance” of this instruction manual.
- The warranty is not valid if payment conditions have not been observed.
- If parts are supplied by some other manufacturer, he is responsible for the warranty of these parts.
- Any controversy shall be governed directly by the court of Competent Jurisdiction.

NOTE: In the event of repairs performed at the place where the machine is installed, the machine guarantee certificate must be presented to the service engineer and the guarantee is valid only if fully completed.

THE GUARANTEE WILL EXPIRE IN THE FOLLOWING CASES :

- Improper use of the machine (see *Improper use pag. 9*).
- Use of different equipment from those specified in Chapter 7 “Maintenance”
- Assembly of the machine in different conditions from those specified in Chapter 4 “Installation”.
- Connections which fail to comply with the specifications given in Chapter 4 “Installation”.
- Use of non-original parts.

REQUEST FOR SPARE PARTS

When requesting spare parts please state the following information :

- Type of machine
- No. Of production order marked on the label.
- Year of production.
- Reference number of the required part which can be found on the correspondent drawing.

1.9 Use of the manual

Read carefully the following chapters : Charter 1 “ General information”, Charter 2 “Safety Information”, Chapter 3 “Machine specifications”, Chapter 5 “Operator interface”. Consult the relevant charter before attempting installation, operation, maintenance or dismantlement.

NOTE: This manual must be kept in good conditions for the whole life of the machine and should be stored where it can be easily found when required. The manual should be handed over to the purchaser of the machine if it is sold to someone else.

1.10 Description of the machine

INTENDED USE: INTENDED OPERATIONS

The machine has been built and designed for cake and bread mixing to obtain shorter working times.

The working cycle can be manual or automatic with two speeds and a premixing cycle, all with timer.

CONDITIONS OF USE INTENDED

The machine has been designed and built to operate in a closed environment, protected from atmospheric agents.

INTENDED USE OF POWER

The machine is driver by electric energy, which is converted into mechanical energy for the intended operations.

IMPROPER USE

Improper use means any operation not expressly stated in the intended uses indicated at the beginning of the paragraph, in particular :

- Use of the machine in an explosive environment
- Use of the machine in a flammable environment
- Washing the machine control panel with jets of water.

MACHINE STRUCTURE

This section describes the main machine components and their function within the production cycle.

MAIN MACHINE COMPONENTS

The machine is composed of the following principal components :

- Body of the machine
- Mixing unit
- Transmission unit
- Electric panel

Fig. 1.2 Main parts of the machine



Chapter2 *Safety information*

2.1 *Safety criteria*

During the design and construction of this machine the manufacturer has adopted the criteria and devices needed to satisfy the essential safety requirements imposed by the Machinery Safety Directive 89/392/EEC and subsequent amendments, by the Low Voltage Directive 73/23/EEC and subsequent amendments and by the Electromagnetic Compatibility Directive 89/336/EEC and subsequent amendments.

The careful analysis of risks carried out by the manufacturer has eliminated most of the risks (predicted or reasonably predicable) linked to the machine operation conditions.

The complete documentation of the safety measures taken is contained in the technical brochure of the machine kept at C.P. s.p.a.

The manufacturer strongly recommends careful observation of the instructions, procedures and recommendations contained herein as well as strict observation of the current safety regulations regarding the work environment. This also applies to the use of both the correct personal safety equipment and machine protection devices.

DANGER: Do not wear loose clothing, ties, chains, or watches that could get caught into the moving parts of the machine.

NOTE: The manufacturer will not be liable for any damage or injury to persons, animals or things caused by non observance of the safety rules and/or recommendations supplied. .

2.2 Qualification of personnel

<i>STAGE</i>	<i>QUALIFICATION OF THE OPERATOR IN CHARGE</i>
Transport	Qualified carrier informed of : Charter 2 <i>Safety information</i> 4.3 <i>Transport</i> on pag. 21 of this manual
Installation	Qualified electrician and qualified mechanic informed of : Chapter 2 <i>Safety information</i> , Chapter 3 <i>Machine specifications</i> , Chapter 4 <i>Installation</i> Chapter 5 <i>Operator interface</i>
Programming and setting up	Qualified programmer and inspector informed of : Chapter 2 <i>Safety information</i> , Chapter 3 <i>Machine specifications</i> , Chapter 5 <i>Operator interface</i> Chapter 6 <i>Machine operation</i>
Operation	Trained worker informed of : Chapter 2 <i>Safety information</i> , Chapter 3 <i>Machine specifications</i> , Chapter 5 <i>Operator interface</i> Chapter 6 <i>Machine operation</i>
Maintenance	There are three different types of workers who can carry out interventions on the machine : <ul style="list-style-type: none"> • Mechanical maintenance engineer : qualified engineer able to operate the machine in normal conditions and with the machine guards open. Able to carry out adjustments, maintenance and repairs on mechanical parts. This worker should not be assigned to electrical interventions on live parts. • Electrician : qualified engineer able to operate the machine in normal conditions and with the machine guards open. Able to carry out electrical adjustments, maintenance and repairs. This worker can be assigned to electrical interventions on live parts inside the electric control box. • Manufacture's engineer : qualified engineer put at customer's disposal to carry out complicated repairing in special conditions, according to the agreements taken with the customer.
Scrapping	Qualified mechanic informed of : Chapter 2 <i>Safety information</i> , Charter 9 <i>Machine scrapping</i>

NOTE: The manufacturer will not be liable for damage or injury to people, animals or things resulting from the actions of unqualified operators.

2.3 Safeguards

DEFINITION

Safeguards are all safety measures which involve the application of specific technical mechanisms (guards, safety devices) to protect people from dangers which cannot be made sufficiently harmless through design.

FIXED AND MOVEABLE GUARDS

- All power transmission components are shielded by screw fastened guards (1), in compliance with the EN 593 standard.
- Safety grille (2) which prevents access to the bowl during the work process.
- Safety guard for the electrical system (3)

Fig. 2.1: Fixed and moveable guards

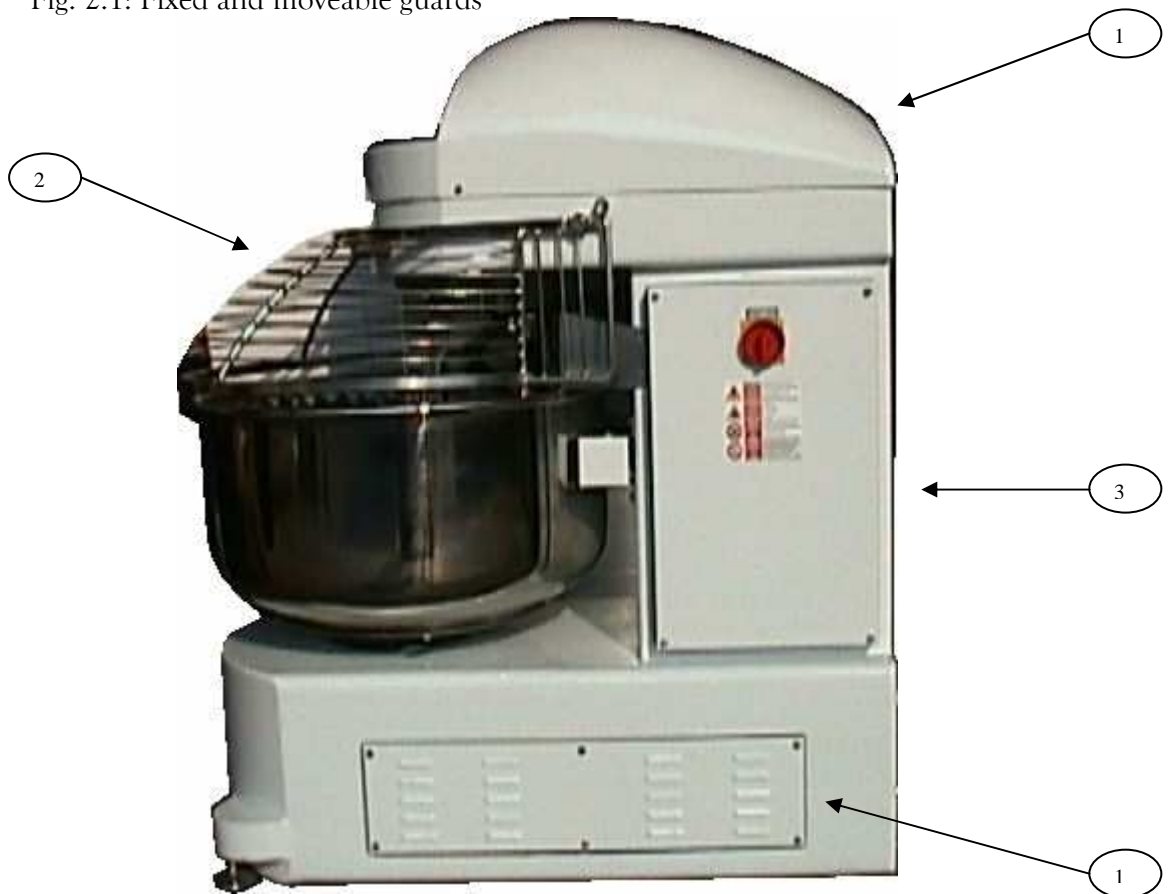

PASSIVE SAFETY DEVICES

DEFINITION

The passive safety devices are those devices or safeguarding techniques which eliminate or reduce potential hazards for the operator without the operator having to actively intervene.

LIMIT SWITCH DEVICES

The machine is equipped with the following limit switch microswitches

- The microswitch SQ1 acts by stopping the machine during operation if the safety grill is lifted (2) Fig. 2.1

Fig. 2.2: Limit switches

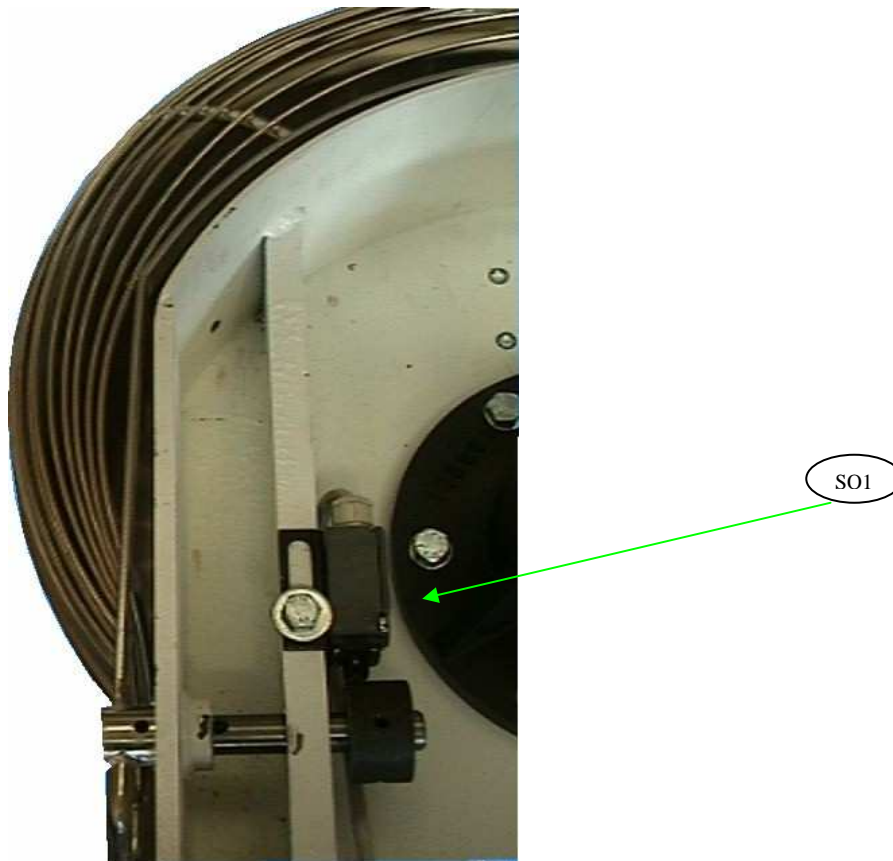

ACTIVE SAFETY DEVICES

DEFINITION

Active safety devices are those devices or safeguarding techniques which eliminate or reduce potential hazards and which require active and conscious intervention by the operator in order to activate their accident prevention action.

EMERGENCY STOP

The machine is equipped with an emergency button **SB1** located on the main control panel of the machine and allows the operator to stop the machine in case of emergency.

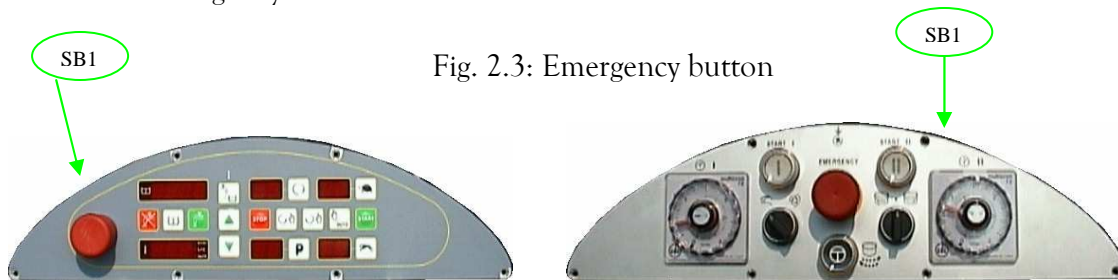

Fig. 2.3: Emergency button

SAFEGUARDING

- The electrical equipment offers protection against personal injury caused by electrical discharge due to direct or indirect contact, all in compliance with the CEI EN 60204-1 standards.
- All electrical power parts are contained in the electrical box protected to IP54, in compliance with the CEI EN 60204-1 standard. The control and power supply voltages for all accessible parts are 12 and 24V for the CPM EL models ; 110V for the CPM models. Moreover, both these lines are protected against short-circuiting and accidental contact to earth.

DANGER: Tampering with the safety devices creates hazards for the machine operators and other exposed persons.

NOTE: The manufacturer will not be liable for injury or damages to people, animals or things caused by tampering with the machine's safety devices.

2.4 Hazardous areas and residual risks

DEFINITION:

A hazardous area is any area inside or near the machine which can constitute a risk for the health and safety of an exposed person.

This manual indicates all the procedures during which residual risks for the operator are present. The residual risks can be eliminated by carefully following the procedures indicated in this manual and by using the recommended personal safety equipment.



Protective gloves must be worn.



Protective footwear must be worn.



Protective overall must be worn.

Handling area of the packed or unpacked machine. The following risks are present here :

- Impact hazard for the operator
- Crushing hazard.

The following PSE must be used by the operator:



Protective footwear, overalls and gloves.

DANGER: The manufacturer will not be liable for damage or injury to people, animals or things resulting from non-compliance to the safety rules or from the recommended PSE not being worn.

Cap3 Machine Specifications

3.1 Technical specifications

Modello Model	Capacità Impasto Dough Capacity	Capacità farina Flour capacity	Motore Spirale Spiral motor	Motore vasca Bowl motor	Dimensioni Dimensions			Peso Weig ht
					A	B	C	
	Kg.	Kg.	kW	kW	cm.	cm.	cm.	Kg.
CPM 80	80	55	2.6 - 4.8	0.66	135	120	75	460
CPM 100	100	65	2.6 - 4.8	0.66	135	120	75	470
CPM 120	120	87	2.6 - 4.8	0.66	135	130	85	485
CPM 160	160	100	7.5 - 10	1.1	160	140	95	800
CPM 200	200	125	7.5 - 10	1.1	160	140	95	820

N.B: Same characteristics for the model "CPM el"

POWER SUPPLY DETAILS:

Tension:

Running voltage : $\pm 10\%$ of the rated voltage.

Frequency:

$\pm 1\%$ of rated frequency in continuous running.

$\pm 2\%$ of rated frequency for a short working period.

NOTE: The manufacturer will not be liable for defects, breakdowns or malfunctioning arising from the non-compliance with the power supply values stated.

Capitolo 4 *Installation*

4.1 *Hazardous areas and residua risks during installation*



Protective gloves must be worn



Protective footwear must be worn.



Protective overalls must be worn

Handling area of packed or unpacked machines

The following risks are present here :

- Impact hazard for operator
- Crushing hazard

The above PSE must be used by the operator.

DANGER: During unloading, hoisting and handling of the machine, personnel must wear the appropriate PSE, such as gloves, boots, helmets and the use of appropriate tools.

4.2 *Qualification of the operator*

The installation of the machine should only be carried out by trained, qualified and authorised personnel after having read and understood the information given in this manual.

4.3 *Transport*

The instructions given in this section must be carefully followed when transporting the machine. This operation may include the following situations :

- Storage of the machine
- Initial installation of the machine
- Re-location of the machine.

TRANSPORT CONDITIONS

The machine and its equipment can be transported in the following ways, according to the customer's requirements :

- In a wooden box pallet
- By road vehicle
- In each of these cases, before transport or handling, the various accessories must be packed and fastened to the machine.

NOTE: Follow standard precautions to avoid collisions and tipping over.

LIFTING

DANGER:

- It is forbidden to climb onto the machine and/or its packing or stop and/or pass under the machine during handling.
- Access to the lifting and handling area is denied to all personnel except those directly involved in the operations.
- All operators should remain at safe distance in order to avoid being hit by the machine or any of its parts which may accidentally fall.
- Before starting the lifting operations the whole of the machine handling area, including the parking area for the means of transport and the machine installation area, should be identified and inspected in order to detect any potentially hazardous areas.
- Use a bridge crane, a crane or a forklift truck with adequate lifting capacity. The use of inadequate lifting equipment may cause damage to the machine or injury to the personnel.
- Check that the hoisting cables or ropes are equipped with a bell and have the label which contain all the manufacturer's details and that the lifting capacity is clearly stated.
- Check the cables or ropes before each lifting operation. Do not use them if they are damaged or worn or have broken strands or wires.
- Never twist or knot ropes or cables. Always follow the instructions supplied by the manufacturer.
- Follow the same precautions when using chains or belts.

Fig. 4.1: Lifting with ropes



Fig. 4.2: Lifting with pallet



ATTENTION: If the machine has been damaged during transport, inform the manufacturer immediately. The manufacturer should also be informed if there are differences between the “ packing list “ and the goods that were actually delivered.

The machine and its equipment should be protected from external atmospheric agents. In particular water and damp can cause certain machine components to rust, causing irreversible damage.

4.4 *Preliminary operations*

CHECK IF THE MACHINE HAS BEEN DAMAGED DURING TRANSPORT

Check the condition of the machine taking a close look at the outside and the inside. Any deformation of the visible parts indicates that the machine has been hit by something during transport. This could lead to malfunctioning.

Check the tightening of screws, bolts and fittings.

If damage has occurred

Damage caused by transport should be attributed to the carrier and the manufacturer or its agent should be informed immediately of the situation.

Cleaning of the machine

- Remove the dust and dirt deposited on the surface during transport.
- Carefully clean and dry each part (varnished or unvarnished) using soft, clean and dry cloths.

ATTENTION: It is strictly forbidden to climb onto the box pallets and/or to stow them one on top of the other.

- Should the box pallets remain outdoors for some time, waiting to be transported inside the building, these box pallets should be covered with adequately-sized waterproof tarpaulins.
- If storage exceeds 3 months the box pallets should be stored inside, sheltered from bad weather and protected from excessively high or low temperatures.
- If the machine is unpacked, it should be covered in order to prevent the build-up of dust and dirt.

4.5 *Installation*

Features of the installation site

A suitable installation site should be chosen considering the overall dimensions of the machine, supplied in chapter 3.1 “specifications” at page 17, and in compliance with the following rules :

- The power supply source, in compliance with the power supply details given on page 17, should be near the installation site.
- Nothing should hinder the free movement of the operator around the machine. The machine should be situated at least 1 metre from the nearest wall or object.
- Cabinets should be accessible at all times and the doors should open wide without obstacle.
- Make sure there is sufficient space for machine operation and maintenance and also for any other additional equipment.

Protection against external atmospheric agents

The machine should be installed in a covered building, shielded from direct contact with atmospheric agents.

Lighting

Adequate lighting is necessary to carry out both normal operation and servicing of the machine in a safe way. The machine has no built-in lighting system.

A well lit environment prevents hazards due to shadowed areas.

Acceptable environmental conditions for the installation site :

- **Temperature :** from 5°C to +40°C with the average temperature not exceeding 35°C over a period of 24 hours.
- **Relative humidity:** from 50% at a temperature of 40°C up to 90% at a temperature of 20°C.

4.6 *Preparation for start-up*

Electrical connections

The machine has only one connection to the main electricity supply

Hydraulic connections

The machine (model CPMel) has only one hydraulic connection. The hose must have a ½ “ fastening.

DANGER: Be sure that the values of the main electricity supply comply with the power specifications of the machine.
Electrical hazards. Be sure that the machine is adequately earthed before making any other connection to the main power supply.

4.7 *Testing*

Before delivery the machine is tested at the manufacture's workshop where the following operations are carried out :

- General setting of the machine, of auxiliary equipment and of the installed safety devices.
- Running test to check all adjustments have been carried out (correct rotation of the motors, tightness of the pneumatic systems, effectiveness of safety devices and of limit switches).
- Performance of test cycles under safe conditions.

Checking the safety devices:

Before starting the machine, the safety devices should be checked according to the following procedure:

- Correct operation of the emergency stop button **SB1** (fig. 2.3, pag. 15); while the machine is working, press the emergency button : the machine should stop immediately.
- Correct operation of the safety limit switches **SO1** (fig.2.2, pag.14); while the machine is working lift the protection grid **2** (fig. 2.1 a pag.13). The machine should stop immediately. .



Cap 5 *Operator interface*

5.1 *Controls*

Model CPM

Fig. 5.1: Control panel CPM









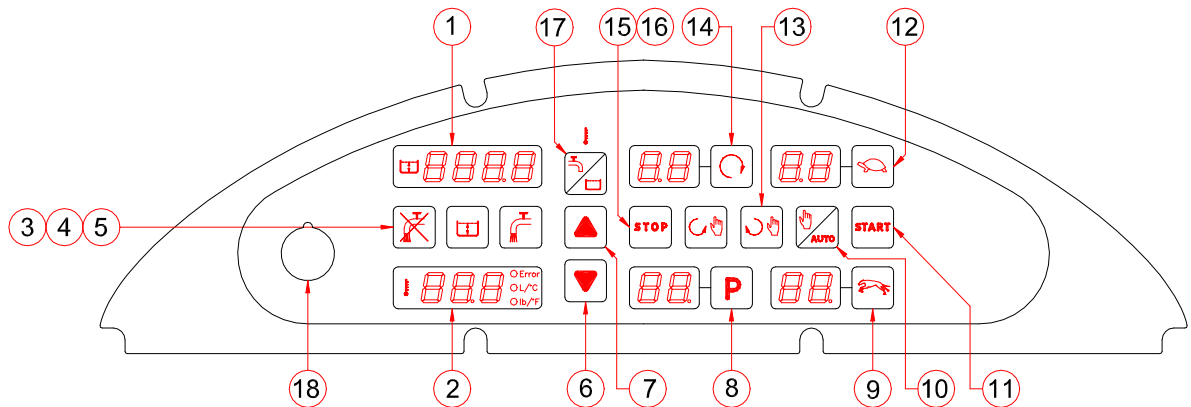







<i>POSITION</i>	<i>DESCRIPTION</i>	<i>FUNCTION</i>
1	Instant button	Jogs the bowl to help the dough extraction.
2	Two position selector	When turned to the left : the manual operation cycle is enabled. When turned to the right : the automatic operation cycle is enabled.
3	Three position selector	Left position: clockwise bowl rotation Middle position: no bowl rotation Right position: anticlockwise bowl rotation
4	Red mushroom button on a yellow background	Emergency button. When pressed it stops the machine completely by cutting off the voltage from the electric circuits.
5	Button I	When pressed the spiral rotates at 1 st speed and the bowl rotates at chosen direction
6	Button II	When pressed the spiral rotates at 2nd speed and the bowl rotates only anticlockwise
7	Timer	Controls time of 1st speed
8	Timer	Controls time of 2nd speed

Model CPMel

Fig.5.2: Control panel CPMel:



<i>POSITION</i>	<i>DESCRIPTION</i>	<i>FUNCTION</i>
1	Display	Indicates the litres to be discharged (during dosing) or already discharged (after pressing the stop button)
2	Display	Electronic thermometer display
3	Button	 Controls manual stop of water discharge
4	Button	 Sets the quantity of water
5	Button	 To start discharge
6 7	Buttons	  To set the quantities
8	Display and button	 To select the program
9	Display and button	 To set the timer in phase 3
10	Display and button	 To select the automatic and manual cycle
11	Button	 To start the automatic cycle
12	Display and button	 To set the timer in phase 2
13	Button	 Commands the clockwise rotation of the bowl with a jog movement
14	Display and button	 To set the timer in phase 1
15	Button	 To stop the cycle manually
16	Button	 Commands the anticlockwise rotation of the bowl with a jog movement
17	Button	 To indicate the water temperature or the temperature of the probe
18	Red mushroom button on a yellow background	Emergency button. Stops the machine completely

Chapter 6 *Machine operation*



6.1 *Qualifications of the operator*

The machine should be used only by trained, qualified and authorised personnel who have read and understood the information contained in this manual. The operator must :







- Pay special attention to the moving parts of the machine
- Take special care when activating the start buttons and only activate them after making sure that persons or things are not in danger
- Do not rest tools or other objects on the machine, weather it is operating or not.

6.2 *Spiral mixer model CPM*

While reading this paragraph always refer to picture 5.1 at pag.23

- Connect the feeling cable to the electric connection and turn the main on-off switch to position "I".
- Be sure the emergency button  is not pressed.
- Be sure that the protection grid  (fig. 2.1 at pag.13) is lowered onto the bowl







MANUAL MODE

- Position the selector  in 
- Decide the bowl rotation direction with the selector 
- Press the button  to start with the 1st speed
- Press the button  to pass to 2nd speed
- Stop the machine lifting up the protection grid
- With the protection grid open the only possible function is the rotation of the bowl with a jog movement using the instant button 

NOTE:

- It is possible to pass to 2nd speed only if the machine is already working.
- The bowl can rotate clockwise only in 1st speed
- To start the machine again after having lifted the protection grid, press the button 

AUTOMATIC MODE

- Position the selector  in 
- Decide the bowl rotation direction with the selector 
- Select the desired time of the 1st speed on the timer 
- Select the desired time of the 2nd speed on the timer 
- Press the button  to put in function the 1st speed, when the selected time has passed the machine will pass to 2nd speed automatically.
- The machine will stop when the cycle has ended
- With the protection grid open the only possible function is the rotation of the bowl with a jog movement using the instant button 



NOTE:

- The bowl can rotate clockwise only in 1st speed
 - To start the machine again after having lifted the protection grid, press the button , the working time selected will remain memorised.
-

6.3 *Spiral mixer model CPMel*

The CPMEL model can control the machine functions through programmable settings. It can also control the Water Doser and the Thermic probe according to the settings programmed by the user.

When reading this paragraph, refer to picture 5.2 on pag.24

- Connect the feeling cable to the electric connection and turn the main on-off switch to position "I".
- Be sure the emergency button  is not pressed.
- Be sure that the protection grid  (fig. 2.1 at pag.13) is lowered onto the bowl





6.3.1 TECHNICAL CHARACTERISTICS

Software	SMDO.01a
Water inlet	1/2 "
Maximum entry water temperature	55° C
Maximum entry water pressure	5 bar
Minimum entry water pressure	1 bar
Maximum dosing	999,9 l
Dosing precision	±1%
Water delivery at 1 bar	25 l/min.
Water delivery at 5 bar	55 l/min.
Tension	12V C.A.
Frequency	50/60 Hz
Power	10 VA



6.3.2 DOSER, INSTALLATION

In case of hard water (high percentage of calcium) it is advisable to use a water softner. This equipment must be programmed in order to leave a residual hardness of approximately 5 to 10 french centigrades.

6.3.3 DOSER, INSTRUCTIONS FOR USE



- Press the button : the display 1 flashes.
- Through the buttons   program the desired quantity of water, this will appear on the display 1..
- Press the button : the valve opens automatically and the dosing starts.
- It is possible to stop water outlet in any moment pressing the button 













The display will show the quantity of water discharged; it is sufficient to press the button  to finish the discharge.

- For every extra dosing of the same quantity, it is sufficient to press button , the doser is equipped with memory. Even in case of loss of power during the working period, the memory will not be lost and it is sufficient to press button to  complete the dosing.

6.3.4 SPIRAL MIXER, INSTRUCTIONS FOR USE

AUTOMATIC CYCLE



To enter in the automatic function mode, press button,  so that on the display  the program number appears.

- Press the button  : on the display the last program selected will flash; use the   buttons to choose a different program.
- Program the quantity of water desired following the instructions of the previous paragraph.
- Press the button  : the time of phase 1 will flash on the display; characterized by the spiral rotating in first speed and the bowl rotating clockwise. To modify use the buttons  
- Press the button  : the time of phase 2 will flash on the display ; this phase is characterized by the spiral rotating in first speed and the bowl rotating anticlockwise. To modify use the buttons  
- Press the button  : the time of phase two will flash on the display, characterized by the spiral rotating in 2nd speed and the bowl rotating anticlockwise. To modify use the buttons.  
- Press the button  to start the chosen program.
- The machine will stop automatically at the end of the cycle

NOTE:

- The phase 1 starts with a delay in relation to the water dosing.
 - The 3 phases are carried out in sequence with a fixed 3 second delay between the first and second phase in order to obtain the complete stop of the bowl before the inversion.
 - Only in phase 2 of the automatic cycle the button  can be used with the following function: while it is kept pressed, the bowl stops its rotation for 2", then it inverts the sense of rotation until the button is kept pressed. When released, the bowl stops again for 2" and it starts the anticlockwise rotation. The phase 2 timer continues the timing regularly and the spiral always rotates.
 - Phase 3 follows immediately phase 2.
-



MANUAL CYCLE:

- All the phases described can be performed also in the manual phase by selecting the butt  : the figure "MA" will appear on the program display and all the other displays will be at zero. To select the phases it is sufficient to press the corresponding button and the display starts to flash. Pressing the start button the corresponding phase start with the display counting the time. Pressing stop the phase stops and the time remains fixed on the display. Pressing the stop button once again the timing goes to zero.
- If the button 2 and 3 are pressed during phase 1, nothing happens.
- Viceversa it is possible to press the button  while in phase 2 and pass directly in phase 3.
- With the machine stopped it is possible to start from any phase, but in phase 3 it is not possible to start directly: the machine does 5" in phase 2 before passing to phase 3
- The machine can be stopped pressing the button 
- In manual mode the doser works separately in relation to the mixers functions.

To go back to the automatic cycles, press again the button  .

NOTE:

With the protection grid open the machine stops immediately. Only the following functions remain active :

- Rotation of the bowl with the two buttons  
 - Doser in manual position
-

NOTE:

When any of the protections are open , the cycle does not start automatically again, but it is necessary to press start.

6.3.5 TEMPERATURE PROBE

The display  normally indicates the entry temperature of the water.

Pressing the button  , the word “TEMP” flashes on the display  ;

while the temperature indication measured by the thermic probe is indicated on the display  .

Chapter 7 *Maintenance*

DANGER : Riscks of electric shocks and sudden movements of the machine during maintenance.
Isolate the machine from electric and hydraulic means.

7.1 *Ordinary maintenance*

For ordinary maintenance we intend all the operations that can be done by the operator. We intend daily cleaning of the machine, periodic inspections in order to avoid future inconveniences enabling the operator to use the machine securely.

The ordinary maintenance operations can be securely fulfilled by the operator only after having read carefully the instructions given in this section.

CLEANING

For a general and constant good working of the machine we suggest a periodic general cleaning. In particular

DANGER : During the general cleaning the machine must be isolated from the main electric and hydraulic means.

For a general and constant good working of the machine we suggest a periodic general cleaning. In particular :

- The machine must be cleaned after every working cycle.
- Keeping the machine cleaned helps to maintain efficient the most delicate parts of the mixer and to enable to note easier any unusual mechanical wear or unfastening.

ATTENTION : Do not use water jets to clean both the control panel and the electric board.

TOOLS AND PRODUCTS FOR CLEANING :

ATTENTION : Avoid use of solvents or similar that could damage the painting or the synthetic material.

Particularly, avoid the use of petrol and trichloroethylene.

<i>PART TO BE CLEANED</i>	<i>HOW AND WHAT TO USE</i>
Stainless steel	Use hot water and a neutral degreaser for food.
Painted steel	Use hot water and a neutral degreaser for food.
Control panel	To clean the panel use a cloth dampened with water and neutral soap ; for more resistant dirt use turpentine.
Electric parts	For all electric parts use a vacuum cleaner.

FREQUENCY :

<i>FREQUENCY</i>	<i>PART TO BE CLEANED</i>
Weekly	Control panel.
Monthly	Motors.
Monthly	Electrical parts
Monthly	Spare parts

7.2 Programmed maintenance

We intend with programmed maintenance all those operations that can be fulfilled by authorised personnel only. Periodic inspections in order to prevent any future failure and to maintain the machines security standards.

QUALIFICATION OF THE OPERATOR

The programmed maintenance operations can be securely fulfilled by qualified personnel trained to use prepare and maintain the machine after having read and understood carefully the contents of this section.

Particular attention must be paid to the belt tensioning.

7.3 Procedure for head belt tensioning

If the belt tension needs to be regulated, proceed as follows :

- Remove the head cover
- Loosen the four screws that sustain the motor (1) without unscrewing them completely.
- Restore the correct belt tension with the screw (2) ; retighten all the screws previously loosened.

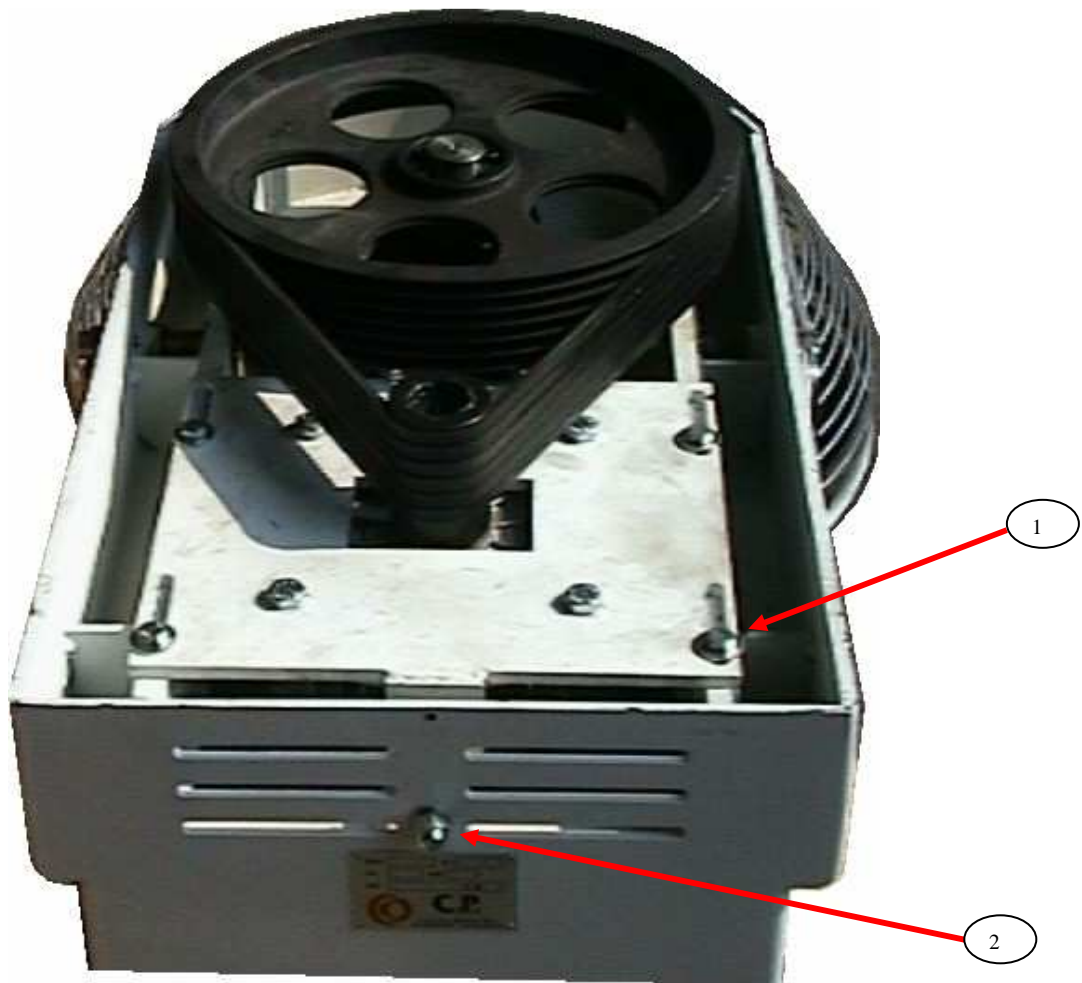

7.4 Procedure for bowl belt tensioning

- Work on the bolts placed on the low left side on the rear of the machine
- To tighten the belts connected to the motor, screw the bolt on the right; the bolt on the left is to tighten the belts of the indirect drive from the motor and the bowl.

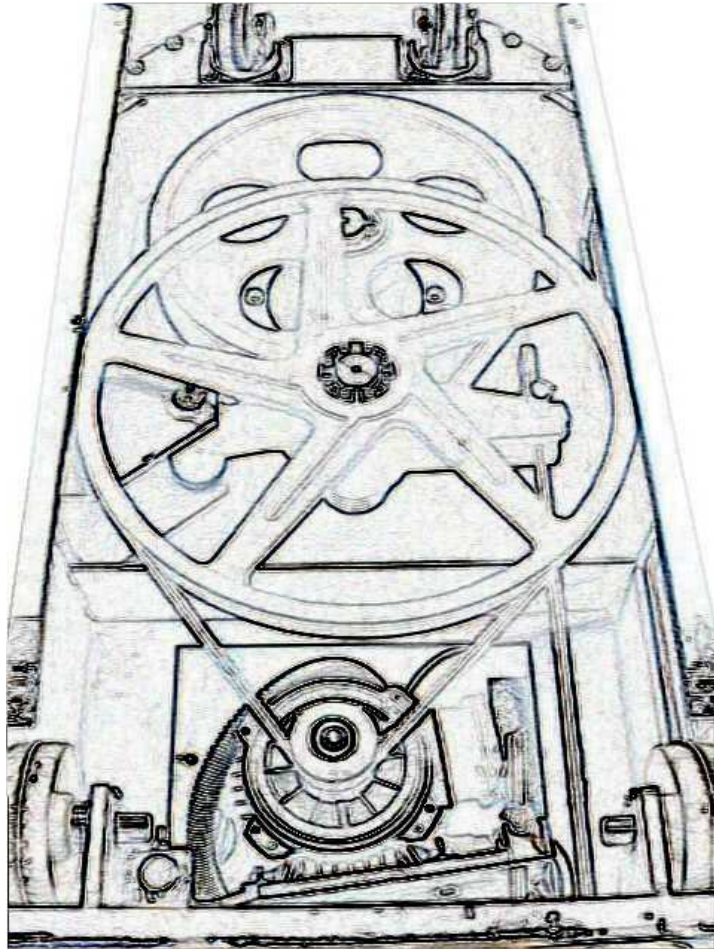

ATTENTION : A too tight tension of the belts could damage the ball bearings of the motor and the belts too.

Chapter 8 *Trouble-shooting*

In this Chapter we introduce and discuss a list of small inconveniences that can occur during the use of the machine.

NOTE : Please contact the assistance service should the problem be different from the ones described or if the problem should persist even after the operators work.



8.1 *Qualification of the operator*

USER

The user can securely use the machine only after having carefully read and understood the recommendations and instructions described in this manual.

MAINTENANCE OPERATOR

To be able to work on the machine, the maintenance operator must be qualified and authorised and must have read and understood the recommendations and instructions described in this manual.

<i>INCONVENIENT CPM SERIES</i>	<i>POSSIBLE CAUSE</i>	<i>REMEDY</i>
The spiral loses speed	The head belts are loose	Tighten the belts as explained in paragraph 7.3
The bowl loses speed	The bowl belts may be loose	Tighten the belts as explained in paragraph 7.4
The buttons of control panel do not respond to any impulse	The automatic switches could be blown	Control and reset the automatic switch, after having checked the cause that made it click.
	A thermal protection could have stopped the machine to protect the electric system	Reset the thermal, after having checked what caused it to overheat
The timers (7) and (8) described in paragraph 5.1 of the CPM series do not control the mixing time.	The selector (2) in paragraph 5.1 may be in the  position.	Position the selector (2) in the position  .
	The timers are in the zero time position.	Set the timers with the desired time.
	The timers are broken	Replace the timers

<i>INCONVENIENT SERIES CPMel</i>	<i>POSSIBLE CAUSE</i>	<i>REMEDY</i>
The writing "Err.L" flashes on the display indicating the quantity.	Water does not reach the machine. The coil is broken	Check the pipeline and the water valve. Call the technical assistance
The numbers do not decrease or they do it slowly on the quantity display.	The internal litre counter is broken	Press the button 3, then the button 5. If the problem persists after 10-12 seconds it means that the litre counter is broken
All the displays are turned off.	No electric connection on the machine	Check that electricity reaches the machine. If there is no problem with the electrics, call assistance.
The writing "Err" flashes on the temperature display.	The internal probe is broken	Call the technical assistance
The writing "Prob/Err" appears on the doser display	The probe is broken	Call the technical assistance
The writing "rEci/Err" appears on the doser display	Electromagnetic disturbances at least four times higher than permitted.	The recipe memory is dirty. Press any button to clear the writing. The recipes are cancelled so they have to be reprogrammed.
The writing "dEF/PAr" appears on the doser display	Electromagnetic disturbances at least four times higher than permitted.	The machine parameters are dirty and the machine has automatically reset. Press any button to clear the writing. The recipes are cancelled so they have to be reprogrammed.

ALLARM DISPLAY SCHEME / ANOMALIES IN THE FOUR LANGUAGES

GB	SPIr/Pro	SPIr/Mot	boul/Mot	Err.L	Prob/Err	Pro2/Err	tEnS/FAI
ITA	SPIr/Pro	SPIr/Mot	UASC/Mot	Err.L	Sond/Err	Son2/Err	MAnc/tEn
FRA	SPIr/Pro	SPIr/Mot	CUUE/Mot	Err.L	Sond/Err	Son2/Err	AbSE/Cou
ESP	SPIr/Pro	SPIr/Mot	CubA/Mot	Err.L	Sond/Err	Son2/Err	FALt/tEn

Chapter 9 *Machine scrapping*

9.1 *Qualification of the operator*

Qualified mechanic that has learned the contents of Chapter 2 *Security information* and those of this Chapter.

9.2 *Disconnecting the machine*

The machine has to be deactivated once it has reached the end of its life span. Disconnecting the machine must be fulfilled in order to prevent it from being used again for its original purpose. Nevertheless, it must be done in such a way that the raw materials that compose it can be reused.

NOTE : The manufacturer is not responsible for any damage to people or things caused by parts of the machine used improperly for purposes different from those on the original machine.

9.3 *Disconnecting procedure*

DANGER : The operations of disconnecting and demolition of the machine must be performed by personnel properly trained and equipped

- Turn off the machine, following the standard procedure.
- Disconnect the main feedings. The procedure is the same as described in Chapter 4 *Installation*. In particular, disconnect the electric feeding cable and the hydraulic feeding hose (for the CPMel series)
- Disassemble the electric and electronic parts.
- Disassemble the hydraulic parts (for the CPMel series)
- Disassemble all the non-metal parts and components.
- In case You need to move the machine, follow the instructions of paragraph 4.3 *Transport*.

9.4 *Residual risks after machine disconnection*

If the instructions of the previous paragraphs have been followed carefully, there are no risks after the disconnection.

ATTENTION : The machine has been built with non-biodegradable material. Take the machine to an authorised deposit for clearing.

Chapter 10 *List of attached documents*

- Document 1: "CE" CONFORMITY DECLARATION
- Document 2: INSPECTION DOCUMENTATION
- Document 3: ELECTRIC SCHEME

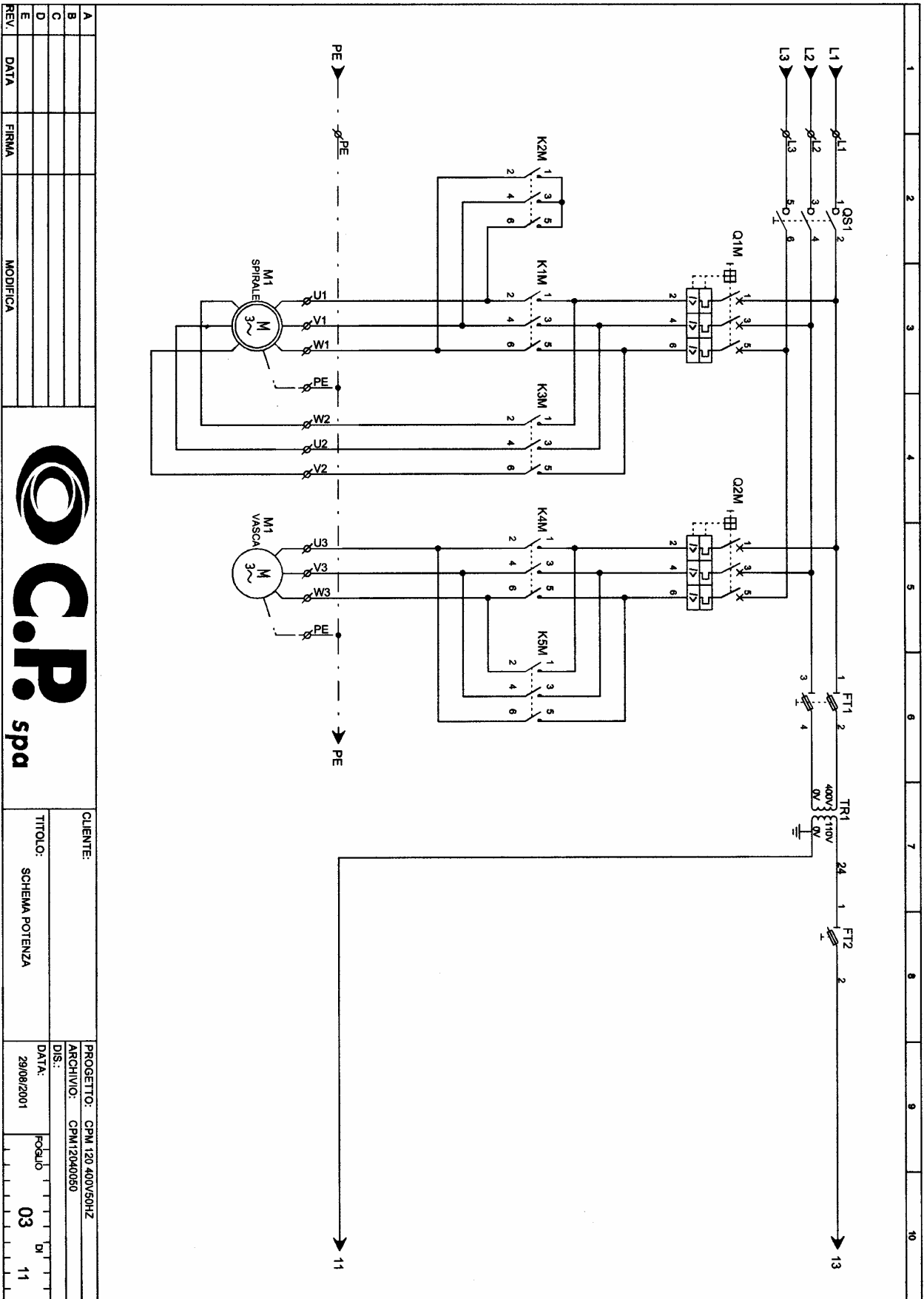

REV.	DATA	FIRMA	MODIFICA
A			
B			
C			
D			
E			

CIENTE:	PROGETTO: CPM 120 400V/50HZ
TITOLO: SCHEMA POTENZA	ARCHIVO: CPM12040050
	DIS: _____
	DATA: 29/08/2001
	Foglio 03 di 11



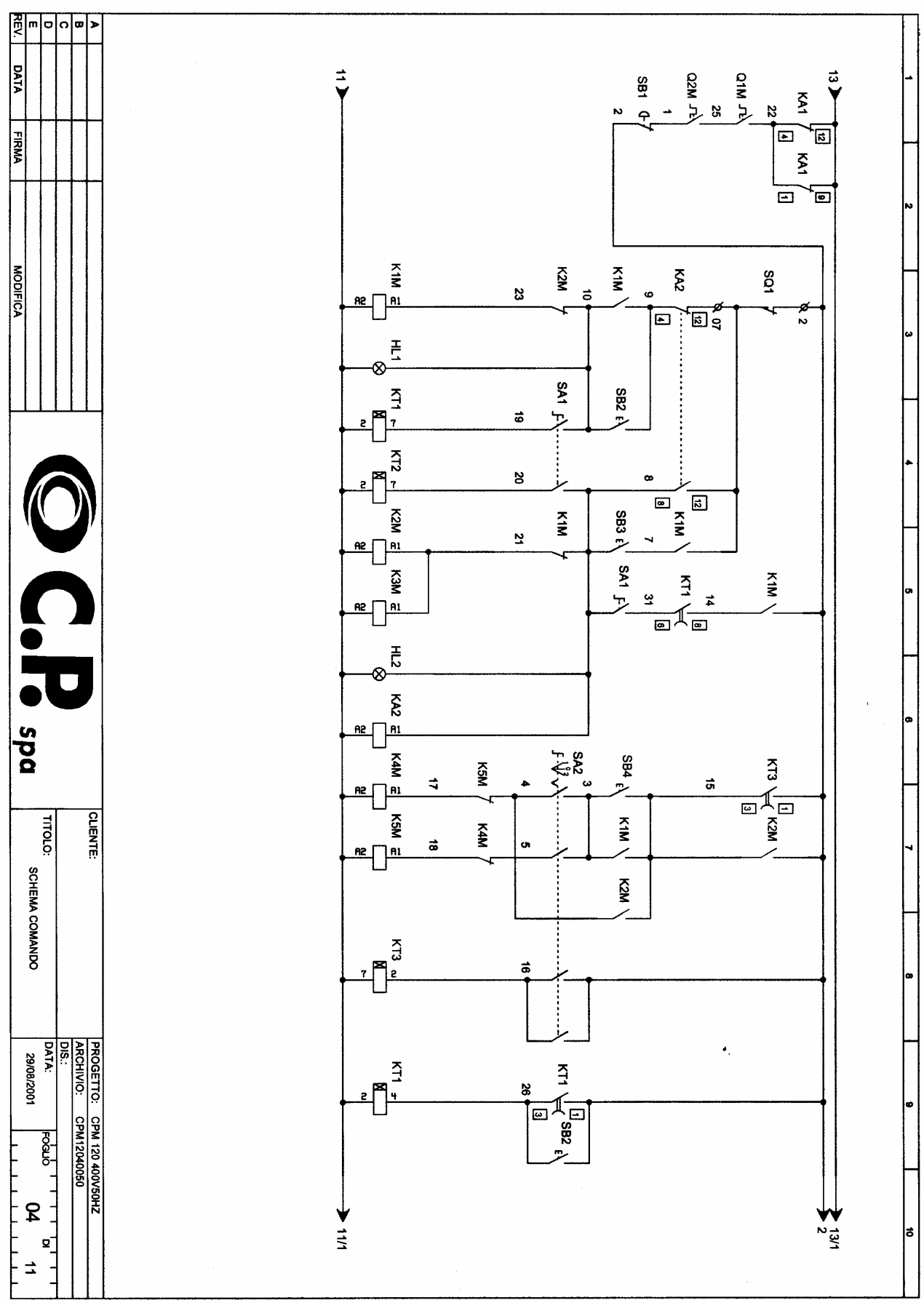

REV.	DATA	FIRMA	MODIFICA
A			
B			
C			
D			
E			

CIENTE:	PROGETTO:
	CPM 120 400V50HZ
TITOLO:	ARCHIVIO:
SCHEMA COMANDO	CPM12040050
	DIS.:
	DATA:
	29/08/2001
	Foglio
	04
	di
	11



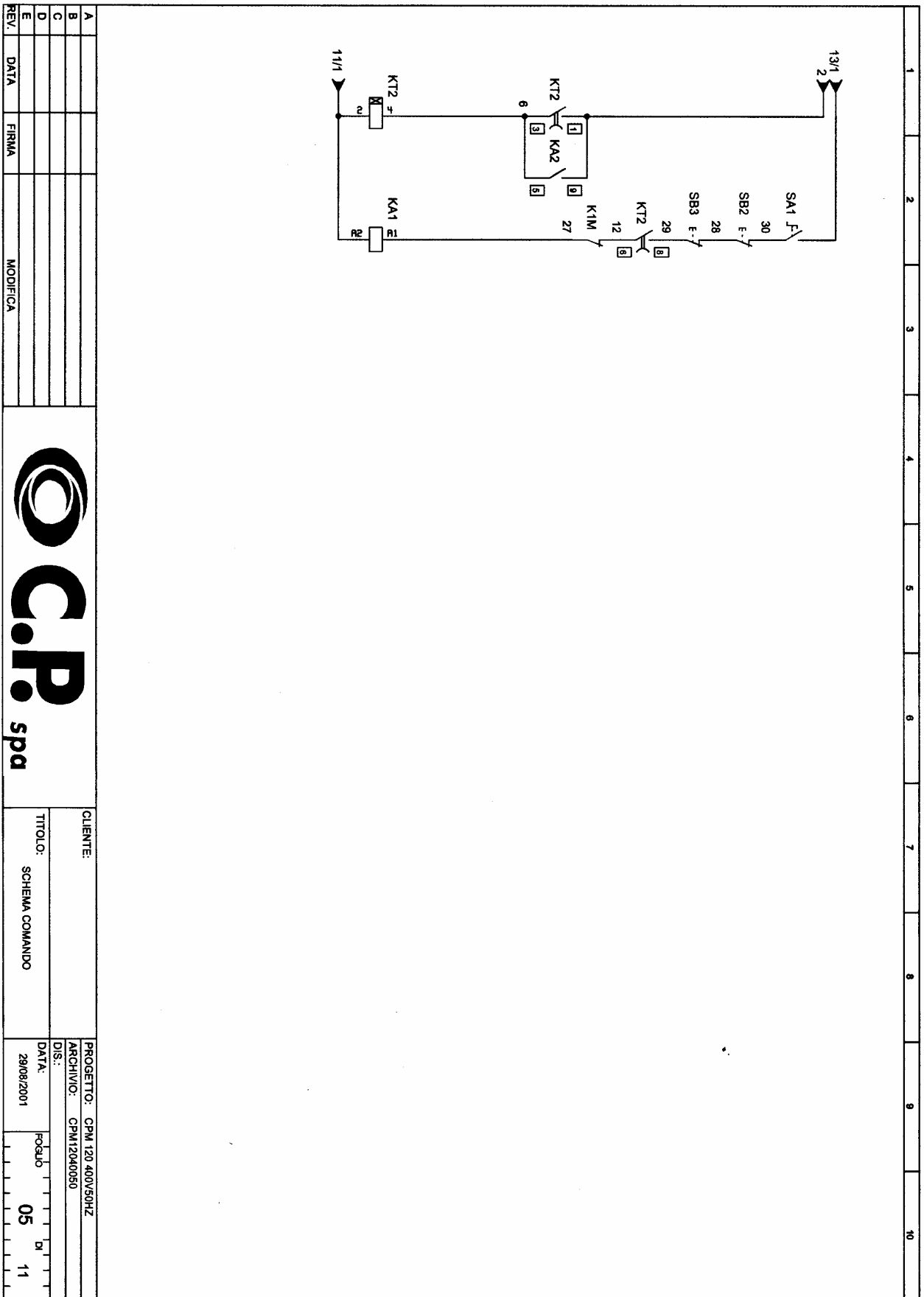

A									
B									
C									
D									
E									
REV.	DATA	FIRMA	MODIFICA						



CLIENTE:	PROGETTO: CPM 120 400V50HZ
TITOLO: SCHEMA COMMANDO	ARCHIVIO: CPM120M050
DIS:	DATA: 29/08/2001
Foglio	di
05	11

A			
B			
C			
D			
E			
REV.			
		CPM 120 400V/50HZ	
		CPM120400S0	
		29/08/2001	06

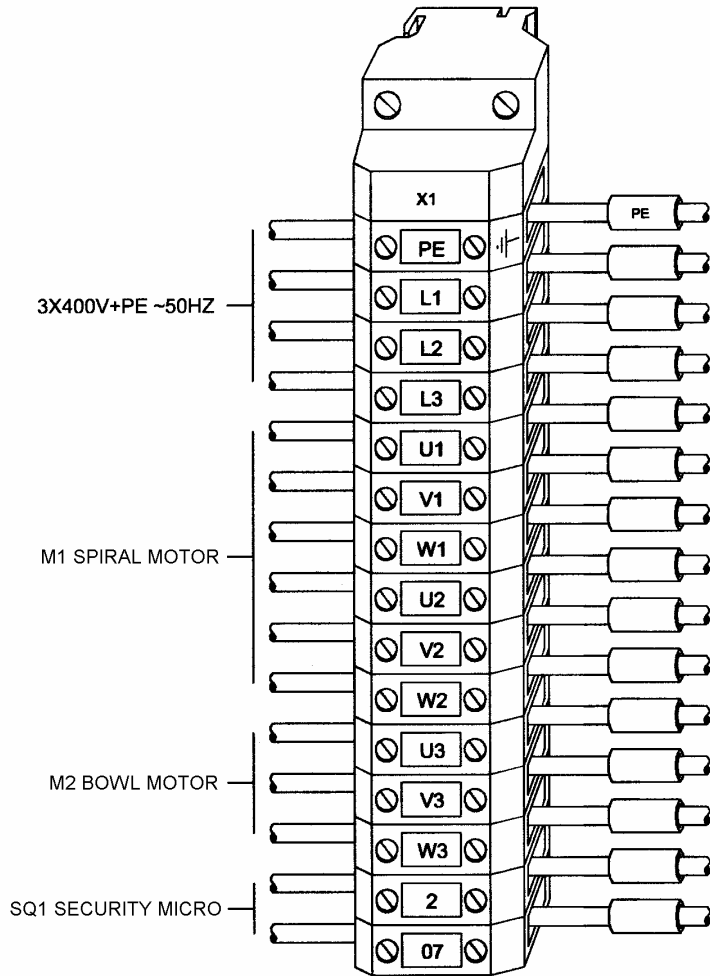

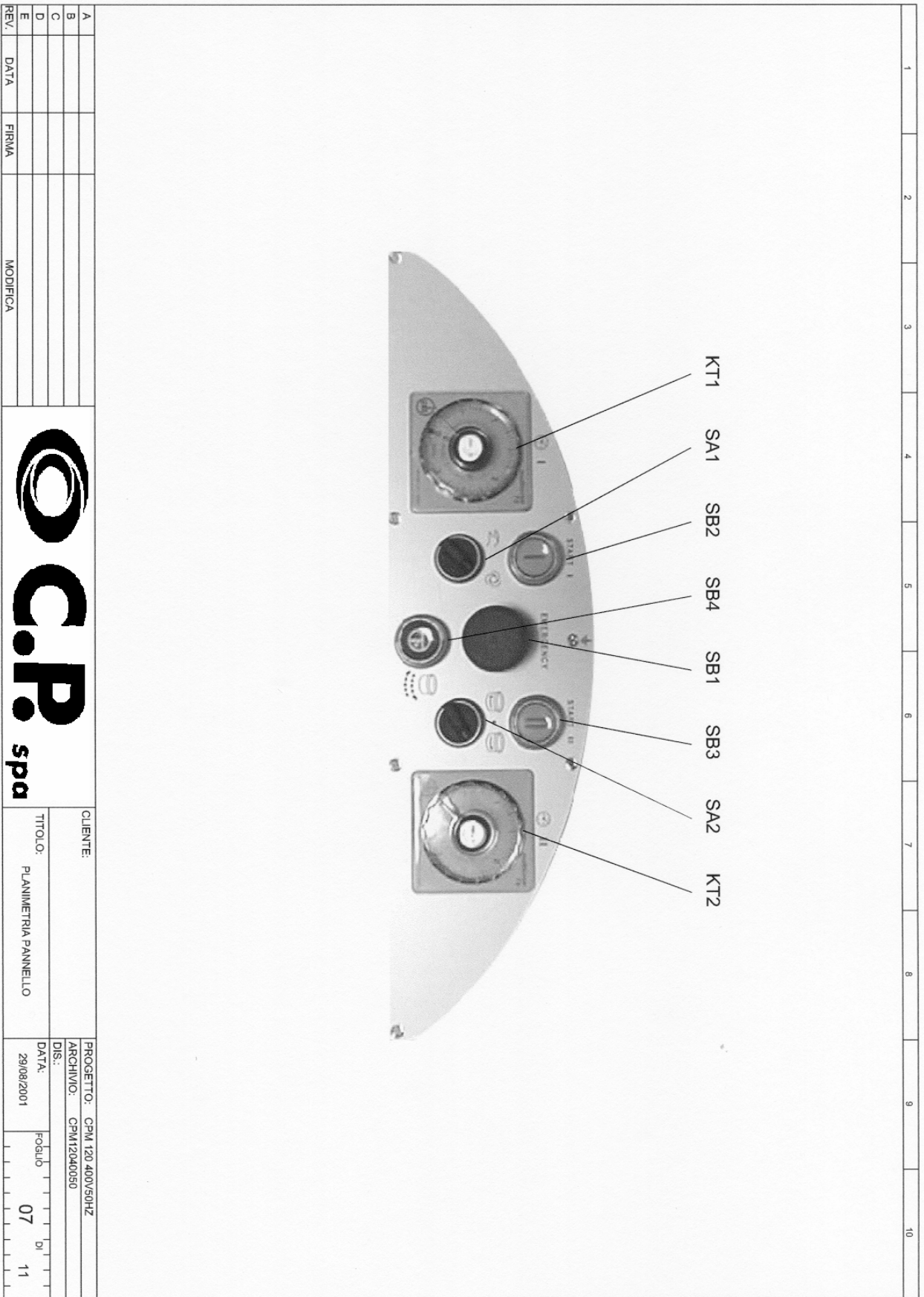

REV.	DATA	FIRMA	MODIFICA
A			
B			
C			
D			
E			

CLIENTE:	PROGETTO: CPM 120 400V/50HZ
TITOLO: PLANIMETRIA PANNELLO	ARCHIVO: CPM12040050
DATA: 29/08/2001	FOGLIO 07 DI 11

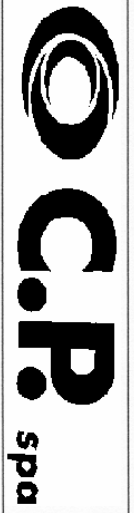

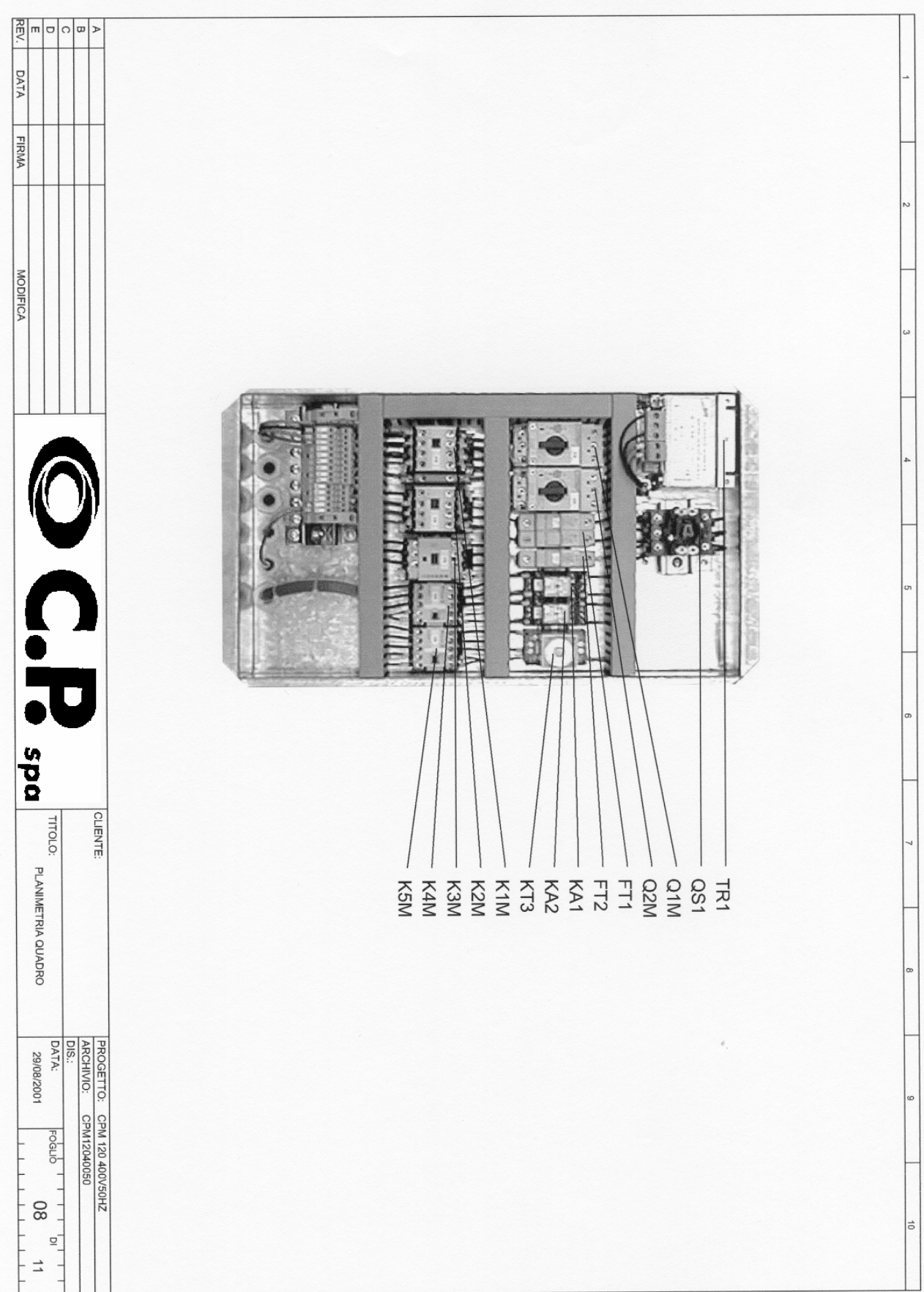

1	2	3	4	5	6	7	8	9	10	
A										
B										
C										
D										
E										
REV.	DATA	FIRMA	MODIFICA							
			C.P.							
			spa							
CLIENTE:			PROGETTO: CPM 120 400V/50HZ							
TITOLO:			ARCHIVIO: CPM12040050							
PLANIMETRIA QUADRO			DIS.:				FOGLIO		DI	
			DATA: 29/08/2001				08		11	

SPECIFICATION LIST

	DESCRIPTION	CODE	MANUFACTURER
FT1	SECTIONABLE BIPOLAR FUSE BLOCK		
FT1	FUSE SERIES CH gG 1A (2A for CPM 160-200)	PCH 2X38	WEBER
FT2	SECTIONABLE SINGLE-POLE FUSE BLOCK	1421002	WEBER
FT2	FUSE SERIES CH gG 2A (6A for CPM 160-200)	PCH 1X38	WEBER
K1M	POWER CONTACTOR	1421006	WEBER
K1M	AUXILIARY EXTRA CONTACT	DIL00M-01(110V/50HZ,120V/60HZ)	MOELLER
K1M	AUXILIARY EXTRA CONTACT	31DILM	MOELLER
K2M	POWER CONTACTOR	11SDILM	MOELLER
K2M	AUXILIARY EXTRA CONTACT	DIL00M-01(110V/50HZ,120V/60HZ)	MOELLER
K3M	POWER CONTACTOR	31DILM	MOELLER
K4M	MINICONTACTOR	DIL00AM(110V/50HZ,120V/60HZ)	MOELLER
K5M	MINICONTACTOR	DILEM-01(110V/50HZ,120V/60HZ)	MOELLER
KA1	4 CONTACT RELAY	DILEM-01(110V/50HZ,120V/60HZ)	OMRON
KA1	RELAY SPRINGLET	MY424AC	OMRON
KA1	4 CONTACT SOCKET	MH0	OMRON
KA2	4 CONTACT RELAY	PE315/4	OMRON
KA2	RELAY SPRINGLET	MY424AC	OMRON
KA2	4 CONTACT SOCKET	MH0	OMRON
KT1	STANDARD 30"-30H 115VA TIMER 1400 SC.602A	PE315/4	OMRON
KT2	STANDARD 30"-30H 115VA TIMER 1400 SC.602A	1400 SC.602A	CDC
KT3	TIMER TF24 SC.814 F.01 6" 115/230VAC	1400 SC.602A	CDC
Q1M	SOCKET FOR RELAY UF3	TF24 SC.814	MOELLER
Q1M	PROTECTION SWITCH 16A (25A for CPM 160-200)	Z393	KUHNIKE
Q1M	AUXILIARY CONTACTORS	PKZM0-16 (PKZM0-25 for CPM 160-200)	MOELLER
		NH-E-10-PKZ0	MOELLER

NOTE:

A									
B									
C									
D									
E									
REV.	DATA	FIRMA	MODIFICA				CIENTE:	PROGETTO:	CPM 120.400V/50HZ
							TITOLO:	Distinta Base (Costruttore)	ARCHIVO:
							DATA:	29/08/2001	FOGLIO
									09
									11

SPECIFICATION LIST

	DESCRIPTION	CODE	MANUFACTURER
Q2M	PROTECTION SWITCH 2.5A (4A for CPM160-200)	PKZM0-2.5 (PKZM0-4 for CPM160-200)	MOELLER
Q2M	AUXILIARY CONTACTS	NHLE-10-PKZ0 (NH111-PKZ0 for CPM160)	MOELLER
QS1	POWER DISCONNECTOR 25A (32A FOR CPM160)	P1-25V/SVB (P1-32V/SVB for CPM 160)	MOELLER
SA1	SELECTOR 0-1	RWK1V	MOELLER
SA1	ACCESSORIE FOR CONTACT ASSEMBLY	BE3	MOELLER
SA1	EXTRA CONTACT	EC20	MOELLER
SA2	SWITCH 1-0-1	RWK3R	MOELLER
SA2	ACCESSORIE FOR CONTACT ASSEMBLY	BE3	MOELLER
SA2	EXTRA CONTACT	EC20	MOELLER
SB1	EMERGENCY BUTTON	RPV	MOELLER
SB1	CONTACT BLOCK NC	BK01	MOELLER
SB2	WHITE START BUTTON	RLT-WS11	MOELLER
SB2	SOCKET BLOCK	BF	MOELLER
SB2	CONTACT BLOCK 1NO	EK10	MOELLER
SB2	EXTRA CONTACT BLOCK 1NO-1NC	EC11	MOELLER
SB2	PROTECTION COVER	MT-D	MOELLER
SB3	WHITE START BUTTON	RLT-WS11	MOELLER
SB3	ACCESSORIE FOR WHITE BUTTON 2ND SPEED	22LT	MOELLER
SB3	SOCKET BLOCK	BF	MOELLER
SB3	EXTRA CONTACT BLOCK 1NO-1NC	EC11	MOELLER
SB3	PROTECTION COVER	MT-D	MOELLER
SB4	NEUTRAL BUTTON	RD-X	MOELLER
SB4	TAG FOR JOG COMMAND BUTTON	43T	MOELLER
SB4	CONTACT BLOCK NO	BK10	MOELLER

NOTE:

A								
B								
C								
D								
E								
REV.	DATA	FIRMA	MODIFICA			CLIENTE:	TITOLO:	PROGETTO:
						Distinta Base (Costruttore)		CPM 120 400V/50HZ
							ARCHIVO:	CPM12040050
							DIS.:	
							DATA:	29/09/2001
							Foglio	10 di 11

SPECIFICATION LIST

	DESCRIPTION	CODE	COSTRUTTORE
SB4	PROTECTION COVER	MT-D	MOELLER
SO1	STOP 1INC 1NA A SC. WITH ROLLER HEAD RS-AT0	ATO-11-S-I/RS-AT0	MOELLER
TR1	TRANSFORMER 150VA 0-230-400/0-1109	T174/014	cre

NOTE:

A									
B									
C									
D									
E									
REV.	DATA	FIRMA	MODIFICA				CLIENTE:	PROGETTO: CPM 120 400V/50HZ	
							TTITOLO: Distinta Base (Costruttore)	ARCHIVIO: CPM12040050	DIS.: